

# ZON™

BEARINGS FOR YOUR FUTURE



Gehäuse und Einsätze / Housings and Inserts





BEARINGS FOR YOUR FUTURE

**Zen Ball Bearings are manufactured to the highest quality for standard and non-standard applications. Our technical department can modify any non-standard bearings to your specific requirements, regardless of quantity.**

Apart from our extensive miniature ball bearing range of more than 1000 different types, ranging from 1-10 mm bore (Including inch dimensions), our range also includes Thin section, Three part thrust, Popular metric and any kind of non standard bearing. We are able to design bearings according to your requirements using new materials like ceramic or special steels for applications in Industry, Medicine, Chemistry and Food Processing.

Our technical department can modify any non-standard bearings to your specific requirements, even for small quantities.

For any items not listed in our catalogue, please contact our experienced sales team.



Zen Ball Bearings Shanghai has been awarded the German ISO TUV Rheinland certification for inspection of ZEN products.

This certification is the highest standard a business in our industry can achieve. It is internationally recognised as a guarantee of quality, customer focus and continual improvement.



## Gehäuse und Einsätze Housings and Inserts



Wetterbeständig\*^▼  
Outdoor durability\*^▼



Geeignet für niedrige temperaturen\*^▼  
Suitable for low temperatures\*^▼



Geeignet für hohe temperaturen\*^  
Suitable for high temperatures\*^



Lösungsmittelresistent\*^▼  
Chemical solvent resistant\*^▼



Geeignet für hohe tragzahlen\*^  
Suitable for heavy load rating\*^



Ölschmierung\*  
Oil lubrication\*



Fettschmierung\*  
Grease lubrication\*



Gummidichtscheiben verfügbar\*  
Rubber seal option available\*



Metalldeckscheiben verfügbar\*  
Metal shield option available\*

\* Stainless Steel Inserts

^ Thermoplastic Pillow Blocks

▼ Stainless Steel Pillow Blocks

www.zen.biz

# Rostfreie Gehäuse / Stainless Steel Pillow Blocks

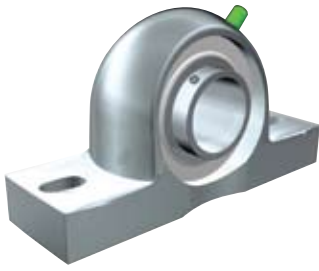

3

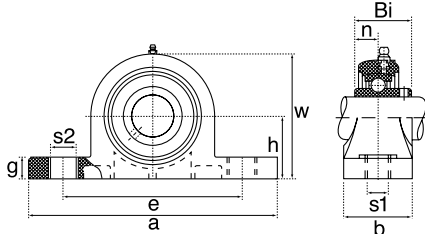

Ref.										Weight	
Type	Da	h	a	e	b	S1	S2	g	w	(kg)	Bearing
SP204	47	33.3	126	95.0	38	11.0	17.5	15.1	65.1	0.69	SUC204
SP205	52	36.5	140	105.0	38	12.5	17.5	16.0	70.0	0.74	SUC205
SP206	62	42.9	165	121.0	48	14.3	21.0	18.0	83.0	1.29	SUC206
SP207	72	47.6	167	127.0	48	14.3	22.0	19.0	94.0	1.42	SUC207
SP208	80	49.2	184	136.5	54	14.3	22.0	19.0	100.0	1.82	SUC208
SP209	85	54.0	190	146.0	54	15.0	22.0	20.0	109.0	2.09	SUC209
SP210	90	57.2	206	159.0	60	18.0	24.0	22.0	114.0	2.38	SUC210
SP211	100	63.5	219	171.0	60	20.0	25.0	23.0	126.0	2.55	SUC211
SP212	110	69.8	241	184.0	70	20.0	25.0	25.0	138.0	3.40	SUC212

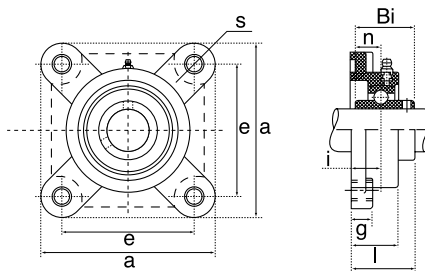

Ref.								Weight	
Type	Da	a	e	i	l	g	s	(kg)	Bearing
SF204	47	86.0	63.5	15.1	25.4	12.0	11.0	0.47	SUC204
SF205	52	95.0	70.0	15.9	27.0	14.0	11.5	0.65	SUC205
SF206	62	108.0	82.5	17.9	30.0	14.0	13.1	0.85	SUC206
SF207	72	117.5	92.0	19.1	33.0	14.3	13.1	1.03	SUC207
SF208	80	130.0	101.6	21.0	36.0	14.3	14.0	1.38	SUC208
SF209	85	137.0	104.8	21.8	37.0	14.3	16.0	1.50	SUC209
SF210	90	143.0	111.0	21.8	38.0	15.1	16.0	1.63	SUC210
SF211	100	162.0	130.0	25.0	43.0	19.5	19.0	3.25	SUC211
SF212	110	175.0	143.0	29.0	48.0	19.5	19.0	4.20	SUC212

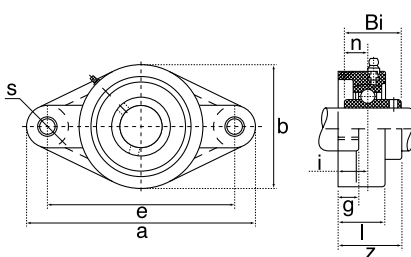

Ref.									Weight	
Type	Da	a	e	i	b	l	g	s	(kg)	Bearing
SFL204	47	112.0	89.7	15.1	60	25.4	11.5	11	0.32	SUC204
SFL205	52	125.0	98.8	15.9	68	27.0	13.0	12	0.44	SUC205
SFL206	62	141.0	116.7	17.9	80	30.0	13.0	12	0.58	SUC206
SFL207	72	155.5	130.2	19.1	90	33.0	14.3	13	0.74	SUC207
SFL208	80	171.5	143.7	21.0	100	36.0	14.3	13	0.99	SUC208
SFL209	85	179.0	148.4	21.8	108	37.0	14.3	16	1.16	SUC209
SFL210	90	189.0	157.0	21.8	115	38.0	15.1	16	1.36	SUC210
SFL211	100	224.0	184.0	25.0	130	43.0	16.0	19	2.20	SUC211
SFL212	110	250.0	202.0	29.0	140	48.0	18.0	23	2.65	SUC212

# Thermoplastische Gehäuse / Thermoplastic Pillow Blocks



4

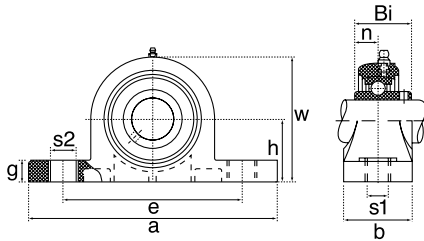

Ref.											Weight	
Type	h	a	e	b	S1	S2	g	w	Bi	n	(kg)	Bearing
TP201	33.3	127.0	95	38	11	14	14.2	65.0	31.0	12.7	0.12	SUC201
TP202	33.3	127.0	95	38	11	14	14.2	65.0	31.0	12.7	0.12	SUC202
TP203	33.3	127.0	95	38	11	14	14.2	65.0	31.0	12.7	0.12	SUC203
TP204	33.3	127.0	95	38	11	14	14.2	69.5	31.0	12.7	0.12	SUC204
TP205	36.5	140.6	105	38	11	14	14.5	71.0	34.0	14.3	0.14	SUC205
TP206	42.9	163.0	118	46	14	18	17.8	84.0	38.1	15.9	0.20	SUC206
TP207	47.6	168.0	127	48	14	18	18.0	94.5	42.9	17.5	0.25	SUC207
TP208	49.2	184.0	137	54	14	18	19.5	99.0	49.2	19.0	0.35	SUC208
TP209	54.0	192.0	146	54	17	20	23.0	106.0	49.2	19.0	0.45	SUC209
TP210	57.2	206.0	159	60	17	20	23.0	114.0	51.6	19.0	0.55	SUC210
TP211	63.5	219.0	171	60	20	23	23.0	125.0	55.6	22.2	1.38	SUC211
TP212	69.5	241.0	184	70	20	23	25.0	138.0	65.1	25.4	1.52	SUC212

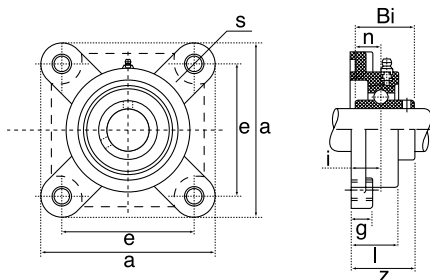

Ref.										Weight	
Type	a	e	g	l	s	z	i	Bi	n	(kg)	Bearing
TF201	86	63.5	13.4	27.8	11	36.3	18.0	31.0	12.7	0.12	SUC201
TF202	86	63.5	13.4	27.8	11	36.3	18.0	31.0	12.7	0.12	SUC202
TF203	86	63.5	13.4	27.8	11	36.3	18.0	31.0	12.7	0.12	SUC203
TF204	86	63.5	13.4	27.8	11	36.3	18.0	31.0	12.7	0.12	SUC204
TF205	95	70.0	14.0	28.0	11	36.7	17.0	34.0	14.3	0.15	SUC205
TF206	107	83.0	14.3	31.5	11	41.4	19.2	38.1	15.9	0.18	SUC206
TF207	118	92.0	15.5	34.8	13	46.9	21.5	42.9	17.5	0.26	SUC207
TF208	130	102.0	17.0	37.5	14	53.2	23.0	49.2	19.0	0.33	SUC208
TF209	137	105.0	19.0	41.0	17	54.2	24.0	49.2	19.0	0.42	SUC209
TF210	143	111.0	21.0	43.0	17	57.6	25.0	51.6	19.0	0.51	SUC210
TF211	162	130.0	20.0	43.0	19	58.4	25.0	55.6	22.2	1.40	SUC211
TF212	175	143.0	20.0	48.0	19	68.7	29.0	65.1	25.4	1.60	SUC212

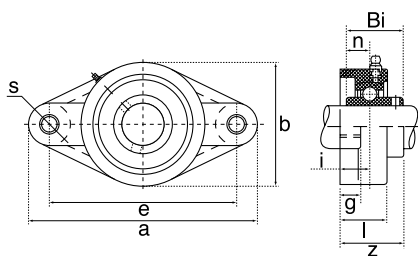

Ref.											Weight	
Type	a	e	b	g	l	s	z	i	Bi	n	(kg)	Bearing
TFL201	113	90	64.0	11.4	26.5	11	33.7	15.4	31.0	12.7	0.08	SUC201
TFL202	113	90	64.0	11.4	26.5	11	33.7	15.4	31.0	12.7	0.08	SUC202
TFL203	113	90	64.0	11.4	26.5	11	33.7	15.4	31.0	12.7	0.08	SUC203
TFL204	113	90	64.0	11.4	26.5	11	33.7	15.4	31.0	12.7	0.08	SUC204
TFL205	131	99	69.6	13.5	29.1	11	36.7	17.0	34.0	14.3	0.10	SUC205
TFL206	148	117	80.0	13.3	30.5	11	41.2	19.0	38.1	15.9	0.13	SUC206
TFL207	164	130	90.0	16.1	32.9	13	43.4	19.0	42.9	17.5	0.16	SUC207
TFL208	176	144	100.0	20.0	37.5	14	51.7	21.5	49.2	19.0	0.24	SUC208
TFL209	188	148	108.0	21.0	41.0	17	54.2	24.0	49.2	19.0	0.32	SUC209
TFL210	197	157	115.0	21.0	43.0	17	57.6	25.0	51.6	19.0	0.42	SUC210
TFL211	224	184	130.0	18.0	43.0	19	58.4	25.0	55.6	22.2	1.40	SUC211
TFL212	250	202	140.0	18.0	48.0	19	68.7	29.0	65.1	25.4	1.60	SUC212

# Thermoplastische Gehäuse / Thermoplastic Pillow Blocks



5

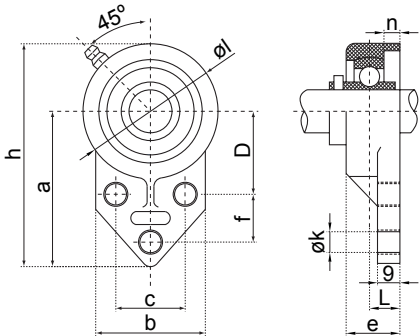

Ref.

Type	Da	a	b	c	D	e	f	g	h	i	k	n	Weight (kg)
FBL201	12	76.2	62	38.1	42.9	33.7	22.2	11.4	108	63.5	10.7	12.7	0.08
FBL202	15	76.2	62	38.1	42.9	33.7	22.2	11.4	108	63.5	10.7	12.7	0.08
FBL203	17	76.2	62	38.1	42.9	33.7	22.2	11.4	108	63.5	10.7	12.7	0.08
FBL204	20	76.2	62	38.1	42.9	33.7	22.2	11.4	108	63.5	10.7	12.7	0.08
FBL205	25	85.7	63.5	41.3	46	41.2	28.6	11.4	120.6	70	10.7	14.3	0.11
FBL206	35	96.5	76	47.6	52.4	41.5	31.8	13.3	138.5	83	10.7	15.9	0.16
FBL207	35	109.5	89	50.8	60.3	47.1	31.8	16.1	157	95	13.1	17.5	0.23

# Rostfreie Lagereinsätze / Stainless Steel Inserts

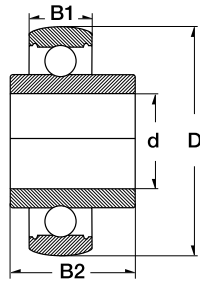

6

Dimension (mm)				Designation/Type	* Load Rating	
d	D	B1	B2		C, dyn. N	C, stat. N
12.0	47.0	17.0	31.0	SUC 201	7500	4500
15.0	47.0	17.0	31.0	SUC 202	7500	4500
17.0	47.0	17.0	31.0	SUC 203	7500	4500
20.0	47.0	17.0	31.0	SUC 204	10000	6300
25.0	52.0	17.0	34.1	SUC 205	11000	7100
30.0	62.0	19.0	38.1	SUC 206	15200	10200
35.0	72.0	20.0	42.9	SUC 207	20100	18100
40.0	80.0	21.0	49.2	SUC 208	23000	18100
45.0	85.0	22.0	49.2	SUC 209	25600	18100
50.0	90.0	23.0	31.6	SUC 210	27500	20200
55.0	100.0	25.0	55.6	SUC 211	33500	29200
60.0	110.0	27.0	65.1	SUC 212	36800	32800

Dimension (mm)				Designation/Type	* Load Rating	
d	D	B1	B2		C, dyn. N	C, stat. N
20.0	52.0	17.0	34.1	SUCX04	13900	7800
25.0	62.0	19.0	38.1	SUCX05	15400	10200
30.0	72.0	20.0	42.9	SUCX06	20300	14000
35.0	80.0	21.0	49.2	SUCX07	23000	16000
40.0	85.0	22.0	49.2	SUCX08	25600	18100
45.0	90.0	24.0	51.6	SUCX09	27500	20200
50.0	100.0	25.0	55.6	SUCX10	34000	25500

[www.zen.biz](http://www.zen.biz)

Alle Rechte vorbehalten, kein Teil des Katalogs darf in irgendeiner Form (Druck, Fotokopie, Mikrofilm oder in einem anderen Verfahren) ohne Genehmigung reproduziert oder unter Verwendung elektronischer Systeme verarbeitet, vervielfältigt oder verbreitet werden.

Copyright reserved. No part of the catalogue is to be copied, extracted or modified without explicit permission from the copyright holder.

v.10 / 12



Bearings for your future